

# WIRELESS REMOTE SWITCH BOX

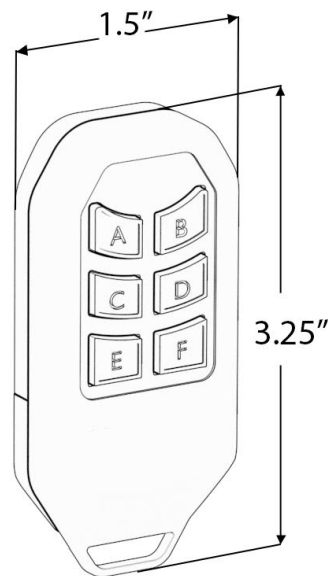

C-RSB

# INSTRUCTION MANUAL

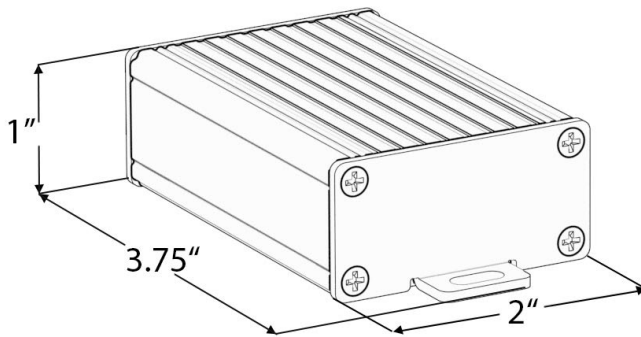
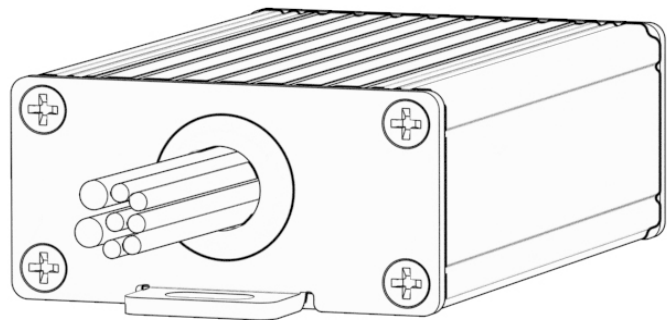
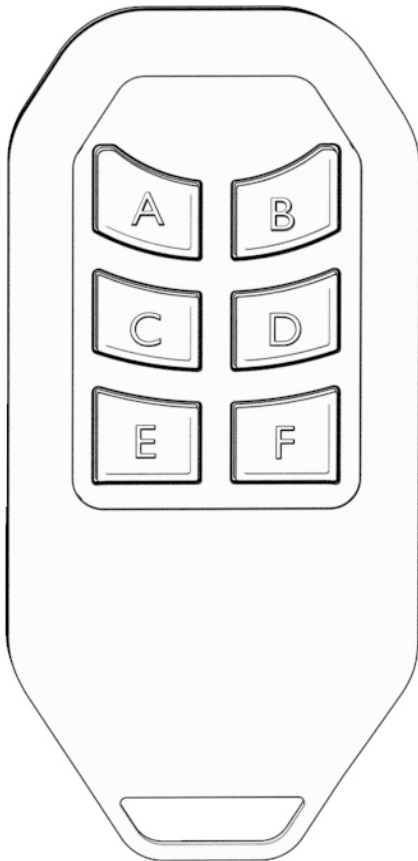

# WIRELESS REMOTE SWITCH BOX

## Warnings and Notices for Users and Installers

This document must be delivered to and read by the end user and installer as it serves to provide you with the required information for proper and safe use of your STL product. Before operating this or any STL products the user and installer must read this manual all the way through. You will find important information in this manual that could prevent property damage and/or serious injury to the user and installer.

STL products are intended to alert pedestrians and other operators of the presence of personnel, the operation of emergency vehicles, an emergency site, and any warning needs. This does not ensure that pedestrians or drivers will react, heed, or observe emergency warning signals. Nor does the use of emergency signals grant or ensure you the right of way. It is your responsibility to make sure you can proceed safely before driving against traffic, entering an intersection, responding at a high rate of speed, or walking on or around traffic lanes.

Your STL emergency vehicle devices should be tested daily to ensure the device and all its functions are operating correctly. If you experience a malfunction contact STL's Customer Service immediately for troubleshooting options, or a warranty or service claim. You must ensure that the projection of the visual and audible signal is not blocked by vehicle components (i.e.: open trunks, visors, compartment doors), vehicles, other obstructions, or people.

This is professional grade equipment and is intended for strict use by authorized personnel only. It is the user's responsibility to understand and obey all laws regarding emergency warning devices. You must know and be familiar with all applicable city, state, and federal laws and regulations prior to the use of emergency vehicle warning devices.

SpeedTech Lights, Inc assumes no liability for any loss resulting from the use of this warning device. Proper installation is vital to the performance of the warning devices and safe operation of the emergency vehicle. Since the operator is under stressful environments the equipment must be properly wired and mounted to ensure effectiveness and safety. Therefore controllers must be properly installed and placed within convenient reach of the operator so eye contact with the roadway is never lost.

The effectiveness of your STL equipment is highly dependent upon correct mounting and wiring. Improper wiring and mounting of the warning device will reduce the output and performance of the equipment. Emergency warning devices frequently require high electrical voltages and/or currents. Properly protect and use caution around live electrical connections. Grounding or shorting of electrical connections can cause high current arcing, which can cause severe personal injury and/or serious vehicle damage, including fire.

Electromagnetic interference can be caused by many electronic devices used in emergency vehicles. To ensure that this doesn't happen to you, Light Bars should be mounted a minimum of 12" - 34" from the radio antenna and do not power your equipment from the same circuit or share the same grounding circuit with radio communication equipment. After installation, test all the vehicle's equipment together to ensure everything operates free of interference.

Driver and/or passenger airbags (SRS) will impact the way you mount your equipment. Any equipment installed in the deployment area of the airbags will damage or dislodge the airbags and sensors. This will also reduce the effectiveness of the airbags to protect the passengers and therefore these areas must be avoided. Installers must make sure that this equipment along with any parts, hardware, wiring, power supplies, and switch boxes do not interfere with the airbags, SRS wiring, or sensors.

All STL equipment needs to be mounted and installed according to the vehicle manufacturer's instructions and securely attached to a part of the vehicle of sufficient strength to withstand the forces applied by the equipment. This device should be permanently mounted within the zones specified by the vehicle manufacturer. This especially applies to equipment mounted on the exterior of the vehicle to avoid dislodging. Mounting units on the interior of the vehicle by a method other than permanent mount is discouraged as it may become detached under aggressive driving conditions such as sudden braking, collision, or swerving.

**PROPER INSTALLATION COMBINED WITH OPERATOR TRAINING IN THE PROPER USE OF EMERGENCY WARNING DEVICES IS ESSENTIAL TO ENSURE THE SAFETY OF EMERGENCY PERSONNEL AND THE PUBLIC.**

## Unpacking Your STL Product

- Unpack your unit to identify all parts including but not limited to: Light Bar, switch box, brackets, screws, bolts, wiring harness, fuses, etc.
- Some parts may be in small bags.
- Some products may be packaged inside boxes of other products.
- Some parts such as Gutter Brackets, may be in the foam protection. Double check that no parts are left within the foam protection or left in the box.



# WIRELESS REMOTE SWITCH BOX

## Important Points for Your Safety and Longevity of Your Light Bar

- Installers are required to have a good understanding of automotive electronic systems and procedures for proper installation.
- Never stare directly into the LEDs as momentary blindness and/or eye damage may occur.
- Never take any lights through a car wash. Use only water to clean the outer body/lens of your equipment.
- Never use a pressure washer to clean any STL products. Inspect and test your product daily to ensure it operates properly and is mounted correctly.
- Never cut wires or work on a unit while the unit is still connected to a power source.
- Never install this product or route any wires through or in the deployment area of the airbag. Doing so may cause serious personal injury as it will damage or reduce the effectiveness of the airbag by causing the unit to become a projectile. Reference the owner's manual for your vehicle to find the airbag deployment area. The User/Installer assumes all responsibility to determine proper mounting location, based on providing ultimate safety to all passengers in the vehicle.
- If the product requires you to drill holes, the installer must ensure that the drilling process does not damage any vehicle components or other vital parts. Check all sides of the mounting surface before beginning to drill. Make sure to deburr all drilled holes and remove any metal remnants or shards to avoid injury and wires from becoming spliced. Grommets are to be installed in all wire passage holes.
- Grommets, cable ties, looms, and other installation hardware should be used to anchor and protect all wiring. Fuses should be properly sized and located as close to the power take off points as possible to protect the wiring and device. To protect against short circuits, a fuse is included by STL for all products. DO NOT use a fuse with a higher amp rating than the initial fuse included by STL for all products.
- Insulation displacement connectors are not to be used.
- In order for STL products to operate at optimum efficiency, a secure and good electrical connection to the battery's Ground Post must be made. The recommended procedure requires the unit's ground wire be connected directly to the NEGATIVE (-) battery post. DO NOT use Circuit Breaks.
- Instruction manuals should be stored in a safe place for reference if you need to reinstall the unit or perform maintenance. They can also be found at the main site under the product listing at [www.SpeedTechLights.com](http://www.SpeedTechLights.com). If your product is no longer available on the website contact STL's Customer Service at 800-757-2581 for assistance.
- If your product requires the use of a control box or remote device to turn on and control your equipment, make sure it is installed in a location that allows both the user and the vehicle to operate safely in any driving condition.
- Never activate or control your equipment in hazardous driving conditions.
- Use SXL type wire in the engine compartment where higher heat resistance is required according to SAE J-1128. All wires should be in accordance with the minimum wire size and other recommendations made by the manufacturer and be protected from hot surfaces and moving parts.
- FAILURE TO FOLLOW THESE SAFETY PRECAUTIONS, WARNINGS, NOTICES, AND INSTRUCTIONS COULD RESULT IN DAMAGE TO THE PRODUCT OR VEHICLE THAT WILL VOID YOUR WARRANTY AND/OR CAUSE SERIOUS INJURY TO YOU AND YOUR PASSENGER.

## Pre-Installation and Testing

BENCH TEST all units prior to installation by connecting the Positive Cable (Red) and Negative Cable (Black) to a power source to ensure all the features and parts of the Light Bar are functional.

### Test Check List:

- LED diode and LED Module functionality
- Flash patterns
- Non-volatile memory
- Physical damage

If you have trouble call Customer Service at 800-757-2581 before proceeding.





## Maintenance

While STL's Light Bars are very durable, there are some things you need to keep in mind and practice to preserve the longevity and function of your Bar.





- Never take any STL Light Bars through a car wash, such as a pressure washer, automatic car wash, brushes that will scratch your equipment or similar car washes or equipment where chemicals, high pressure water, and materials may scratch or damage your equipment.
- Use Water (H<sub>2</sub>O) with a soft cloth to clean your Light Bar and lenses.
- Yellowing of clear lenses may occur overtime. Lenses can be purchased by calling STL Customer Service at 800-757-2581.

# WIRELESS REMOTE SWITCH BOX

## Wiring Diagram

Wire Color	Function
 Red*	Positive
 Black*	Negative
 Grey	A (Toggle Power Switch)
 Green	B (Toggle Power Switch)

\* Indicates a main power cable.

Wire Color	Function
 Yellow	C (Toggle Power Switch)
 Orange	D (Toggle Power Switch)
 Brown	E (Toggle Power Switch)
 Blue	F (Momentary Switch)

NOTE: All cables except Negative contact +12 VDC.

**NOTE: The wireless antennae is the long black cable. Obstructing this cable could decrease effective range.**

## Wiring Lights to Switch Box

- Connect the Red cable labeled "+" to the Positive post of the battery.
- Connect the +12 VDC main power cable of a light unit to the desired A, B, C, D, or E position.
- Connect the flash pattern cable of a light unit to the Blue cable to have the F position change flash patterns (positive switching).
- Join all Negative cables from connected light units with the Black Switch Box cable labeled "-", and ground them at the Negative post of the battery.
- NOTE: Solder and heat shrink each wire. DO NOT cross connect wires or leave connectors, cables, solder points exposed to heat, moisture, or debris. DO NOT expose unit to heat or moisture.

## Extension Cable (Sold Separately)

- You will solder and heat shrink each wire you are extending.
- NOTE: DO NOT cross connect wires or leave connectors, cables, solder points exposed to heat, moisture, or debris.

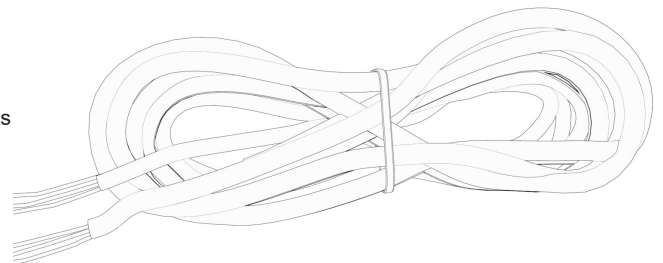

# WIRELESS REMOTE SWITCH BOX

## Pairing Key Fob Remote to Base Unit

NOTE: The Wireless Remote Switch Box will initially come pre-programmed out of the box.

- If the original Key Fob needs to be replaced, the Base Unit must first be unpaired.
- Open the Base Unit by removing the (8) screws; (4) screws on each end.
- Key Fob uses A23 size batteries.

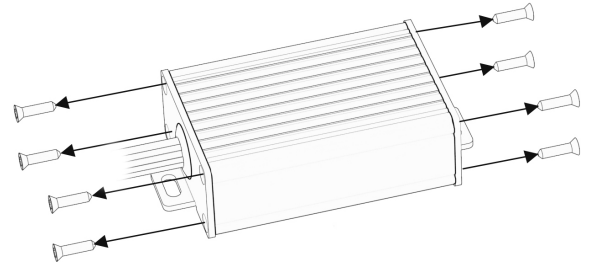

- After removing all screws, the board can now be pulled out from its housing.

NOTE: Always grip the side of the board to minimize contact with any of the ESD (Electrostatic Discharge) sensitive components. Even without voltage running through board it is still possible to damage components through electrostatic discharge. Handle with care.

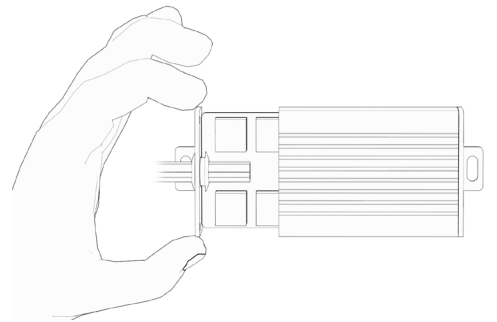

- Locate the rectangular white button near the center of the board.
- Connect the board to any +12 VDC power supply.

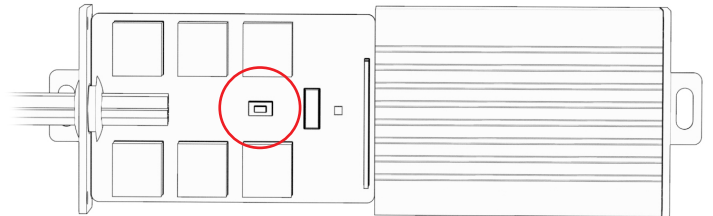

- Hold down the white button until the LED illuminates (as shown in image). This will indicate that the unpairing was successful.
- The Base Unit is ready to pair with a new Key Fob. With the LED still illuminated, press any button on the new Key Fob. The LED on the board will now start to blink indicating a successful pairing. If the LED does not blink, unpairing may have been unsuccessful. Repeat the step for unpairing and try again.
- Once a successful pairing has been indicated, disconnect and reconnect power to the Base Unit, and test the new Key Fob to ensure it is functional.
- Reassemble the Base Unit and the Wireless Remote Switch Box will be ready for use.

