

















ACARI RTM-LP SERIES PART LIST:

<u>DESCRIPTION</u>	<u>(QTY)</u>	<u>IMAGE</u>	<u>PART NUMBER</u>	<u>REFERENCE NUMBER</u>
LP SERIES PLATFORM	(1)		LP-101-A	1
LOWER EXTRUSION	(1)		ACE-7	2
WINDSEAL VINYL	(1)		W-BM	3
VEHICLE SPECIFIC BEZEL	(1)		Located on box	4
METAL CLAMPS	(2)		ACE-8	A
ADHESIVE CLAMP PADS	(2)		CP-FORD	B
VEHICLE SPECIFIC BEZEL	(2)		N/A	C
FOAM STRIPS	(2)		FI-COM	D
FASTENER BAG	(1)	*CONTENTS LISTED BELOW*	F-KIT-23	E

ACARI RTM-01 SERIES PART LIST:

<u>DESCRIPTION</u>	<u>(QTY)</u>	<u>IMAGE</u>	<u>PART NUMBER</u>	<u>REFERENCE NUMBER</u>
01 SERIES PLATFORM	(1)		ACE-2.1	1
LOWER EXTRUSION	(1)		ACE-7	2
WINDSEAL VINYL	(1)		W-BM	3
VEHICLE SPECIFIC BEZEL	(1)		Located on box	4
PLASTIC ENDCAPS W/ GASKETS	(2)		EC-UR (RIGHT) EC-UL (LEFT)	5
METAL CLAMPS	(2)		ACE-8	A
ADHESIVE CLAMP PADS	(2)		CP-FORD	B
VEHICLE SPECIFIC BEZEL	(2)		N/A	C
FOAM STRIPS	(2)		FI-COM	D
FASTENER BAG	(1)	*CONTENTS LISTED BELOW*	F-KIT-23	E

Fastener Bag Contents

E1. (2) 1 ½" Hex Bolt

E4. (4) Lock Washers

E2. (6) 1" Button Socket Cap, Black Oxide Finish

E5. (2) Flat Washers

E3. (2) ¾" Pan Head Screw

****KIT PACK #'s 12-1, 13-1, 23-1, & 33-1 will contain a piece of adhesive strip foam****

ACARI™

ENGINEERING COMPANY, LLC

PO Box #1135 Deep River, CT 06417

Phone: (860) 510-0134

Sales E-mail: info@acariproducts.com

Please Contact Us with Any Questions or Concerns

Installation Guide:

ACARI RTM

22", 28", 34"

LP & 01 Series

Safety First! *View our helpful install video at www.acariproducts.com*

These instructions provide all the necessary directions and information to allow your ACARI RTM (Roof Top Mount) to be installed safely and properly. Before beginning the installation of your new ACARI RTM, please have the installer and the operator read these directions thoroughly. Important information regarding the safe installation and safe operation of your ACARI RTM is contained that could prevent serious damage and injury to yourself or others.

The ACARI RTM is designed to facilitate the quick and simple installation of accessories normally mounted to the roof of a pickup truck. Our product provides a durable platform onto which these accessories may be mounted without requiring holes to be drilled into the cab roof for fastening or wiring access. ACARI provides a system of weather-resistant gaskets and deflectors designed to redirect wind and moisture in common applications. **PLEASE NOTE; ACARI RTM is not designed to be weather-proof in the event of power washing, mechanical car washing, or other forces beyond normal highway operation.**

It is the *responsibility* of the owner/operator to periodically inspect the RTM to be sure *the clamping system remains secure* and the *weather resistant gaskets are tight*.

The ACARI RTM is designed to provide a mounting platform for lighting, antennas, GPS, and other accessories. In no way is the ACARI RTM to be used as a load bearing rack for ladders or other equipment or supplies. The recommended weight restriction of the ACARI RTM is 30 lbs.

The ACARI RTM is designed to provide a mounting platform but in no way provides advice on the possible electronic effect of mounting various devices within any proximity to another. The ACARI RTM is manufactured of anodized aluminum but is mounted to the vehicle with gaskets to provide a water-resistant bond and protect the finish of the vehicle. As such, the ACARI RTM **may not** be grounded to the vehicle without the installation technician applying an appropriate grounding mechanism.

MOUNTING THE UNIT: *View our helpful install video at www.acariproducts.com*

The ACARI Drill-Free Roof Top Mount (RTM) has been designed with a commonality of many parts for different vehicle installations. Each vehicle type has a corresponding mounting kit designed specifically to fit the shape and contours of the interior and exterior of the truck cab. Each set of instructions is common overall with vehicle specific notations to highlight individual model applications.

*****IMPORTANT NOTE:** Supplemental Instructions for the 01 Series Mount will have a .1 following the instruction number. Follow these instructions when installing a 01 Series Mount. ****

1. Open ACARI RTM package and remove all parts. Confirm proper mounting kit # on front of box for your vehicle model type.
2. **Lower Mount Preparation:** Remove Aluminum components from shipping position inside the box. Remove the Lower Extrusion(#2) from its shipping position by removing screw. Set lower extrusions aside. **2.1 Slide out the unsecured end cap and gasket(#5), then remove the Lower Extrusion(#2) from its shipping position. Set aside.**
3. Open the vehicle specific kit pack. Remove the 4" x 2 1/2" clamps(A). Apply the adhesive clamp pads(B) to the top of each, aligning with the front edge. One at a time, set rounded end of clamp into the pivot channel of Lower Extrusion and align with the mounting slots. Insert bolt through slot with flat washer(E5) closest to the slot and lock washer(E4) closest to the bolt head. Thread loosely into clamp so the round end of clamp will not fall out of pivot channel.
4. Position the **Vehicle Specific Bezel(#4)** onto the lower mount by inserting the upper and lower plastic endsheet of Bezel into the aluminum channel slots on Lower Extrusion. Align the mounting holes on Bezel endcaps with screw boss in the Lower Extrusion. Clip the plastic tabs on the leading edge of the Bezel end caps under the Lower Extrusion, just behind the wind seal vinyl(#3). Fasten with one Button Socket Cap, black screw(E2) on each endcap.
5. Install the two **Vehicle Specific Profile Adapters(C)**, then slide to align with the outside edges of the Bezel End Caps. Install the 1/2" x 1/2" x 15" foam strip(D) into the aluminum channel adjacent to the wind seal vinyl. Apply the second foam strip into the aluminum channel at the bottom of the aluminum housing. Both foam strips will align with the thickness of the Vehicle Specific Profile Adapter at their location.

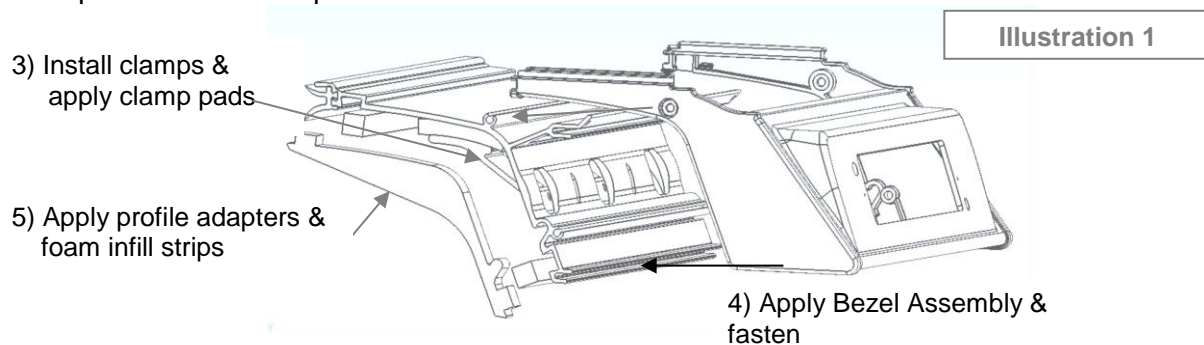

6. **NOTE**:** With some vehicles, a third foam infill piece identified by an adhesive tape strip will be included**. Remove the paper backing tape and attach to the indented cab roof sheet metal below the 3rd brake light or CHMSL (Cab High Mount Stop Light) light opening, parallel to the top of the rear window.
7. **Upper Platform(#1) Preparation:** Mount and fasten lights or other accessories to be installed on the upper platform by attaching and fastening each accessory to their manufacturers' installation requirements. All wiring should include 8 to 10 inch leads and connectors. At same time, make up the corresponding wire harness for connection inside the vehicle. Lengths will vary.
8. **Vehicle Preparation:** Remove the two mounting screws securing the CHMSL. Remove light housing from truck body, detach wiring connector, and set aside for re-installation at end of the upfit.
9. For any accessories mounted to upper platform; install the corresponding accessories' wiring harness through the CHMSL hole into the vehicle and snake through the interior for connection. Be sure to leave enough wire length for maneuvering and attachment of connectors at the end of the upfit.

10. **Installation of the Lower Mount:** Pull all harness wires and CHMSL lead through the access hole between the clamps while easing the clamps up and into the cab body. In some cases, the clamp bolts must be pulled back while installing to insure the clamps slide up along the interior of the roof and not get hung up on interior roll bar structure. *May require multiple attempts to create a level surface. Be sure to push clamps as far into the CHMSL opening as possible.*

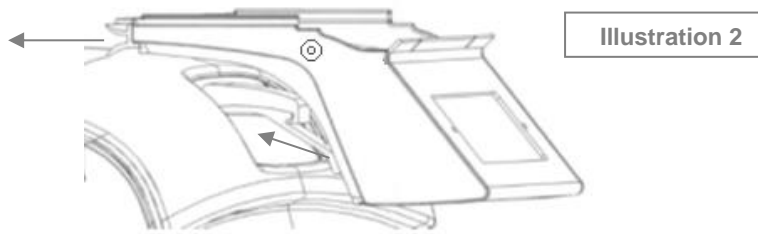

11. **BE SURE TO CENTER AND LEVEL THE LOWER MOUNT ON THE VEHICLE CAB.**
Tighten the clamp adjustment fasteners to take up the slack until the gaskets fit uniformly against the profile of the cab body. Sight the leading edge of Lower Extrusion as a reference for level and true. Final tighten both clamp fasteners equally to flatten the lock washers, 15-18 ft/lbs each.

12. **Installation of the Upper Platform:** Holding the Upper platform off-center to the lower mount, drop the wiring leads into the Lower Extrusion. Next, slide the projection tongue on the forward edge of the Lower Mount into the slot on the forward section of the Upper Platform. Be sure the slot on the forward section of the upper housing captures only projection tongue on the lower mount and not the wind seal vinyl. When inserting, be careful the wind seal vinyl compresses evenly for proper performance. Finally, compress the interior gaskets in the LP Upper Platform against the endcaps of the Lower Mount, aligning the slots and holes, and fasten with the $\frac{3}{4}$ " pan head screws(E3). **12.1 Finally, slide the upper platform to the centered position, aligning the slots and holes, and fasten with the $\frac{3}{4}$ " pan head screws(E3) provided.**

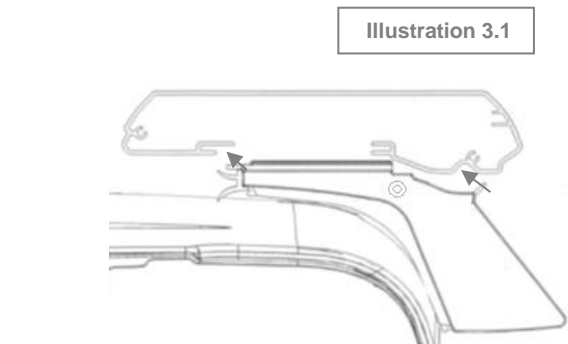
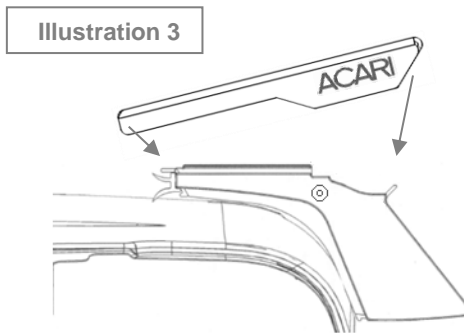

- 13.1. Slide remaining end cap assembly into the Upper Platform and position the endcap gasket. Slide into place making sure the edge of the filler panel locks into the slot of the Lower Mount endcap. Fasten the Upper Platform endcap using the provided black stainless fasteners. DO NOT OVER TIGHTEN!**

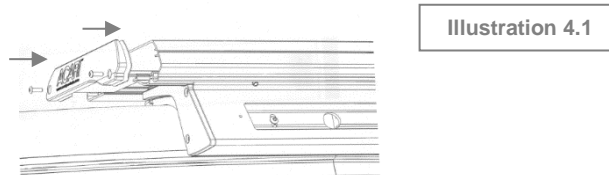

Connect the new apparatus' wiring harnesses and test. Reconnect the CHMSL harness and reinstall into Vehicle Specific Bezel opening with original factory fasteners and gaskets.



USER DIRECT ONE YEAR WARRANTY

ACARI Engineering Company, LLC warrants products of its manufacture against defects in material and workmanship. This is provided that the product has been installed and operated in accordance with the manufacturers' recommendations. During the warranty period, an Authorized ACARI Repair Center will repair or replace (at its option) any parts or assemblies of the unit which disclose a defect in material or workmanship. The Repair Center will return the repaired unit, transportation cost prepaid.

The above warranty is between the first purchaser (ultimate user) only and ACARI Engineering Company, LLC (manufacture). No prior authorization is required for returning ACARI products for warranty consideration. Each ACARI product sold is covered only by the official warranty in effect at time of purchase.

This warranty is not applicable to any ACARI product that has failed due to abuse, misuse, improper installation, and excessive alterations to the product that affects, in the manufacture's judgment, intended use and service. ACARI will not be held liable for any incidental or consequential damages, and assumes no responsibility or liability for expenses incurred in the removal and/or re-installation of products requiring services and/or repair; nor the packaging, handling, and shipping to the Authorized ACARI Repair Center; nor the handling of products returned from the repair center after service or repair. **There are no other warranties, expressed or implied, including, but not limited to, any implied merchantability or fitness for a particular use.** ACARI Engineering Company, LLC reserves the right to modify this warranty statement at any time; or discontinue, modify, or upgrade any products of its manufacture with design improvements without prior notice.

This warranty gives you specific rights, and you may also have other rights which vary from state to state.

ACARI products are covered by a direct warranty for up to a maximum one year from date of purchase (not to exceed two years from the date of manufacture), with proof of purchase. In accordance with the policy statement described herein, the unit may be returned directly to the Authorized ACARI Repair Center for warranty consideration.

STEPS TO BE TAKEN FOR WARRANTY RETURN:

1. ACARI products are to be returned freight prepaid to the Authorized ACARI Repair Center.
2. A copy of the sales receipt must be returned with the defective unit to qualify for warranty coverage from date of purchase.
3. Include a short statement explaining the problem.
4. Include your name, address, and day-time telephone number.
5. ACARI and its Authorized Repair Centers will, via UPS, ship back the repaired unit **freight prepaid**, usually within a few days after its receipt.

The only AUTHORIZED ACARI REPAIR CENTER(S) are predetermined by the ACARI Factory via official listing obtained from ACARI Engineering Company, LLC.

ACARI™ Engineering Company, LLC

PO Box #1135, Deep River, CT 06417 · Phone: (860) 510-0134 · www.acariproductions.com